

**marinepeyre**

e d i t i o n s



SANDWICH

# SANDWICH

CRÉATIF

CREATIVE

INVENTIF

INVENTIVE

AUDACIEUX

AUDACIOUS

MODULABLE

MODULAR

MINIMAL

MINIMAL

LUDIQUE

PLAYFUL

RESPONSABLE

RESPONSABLE

ELEGANT

ELEGANT

FABRIQUÉ EN FRANCE

MADE IN FRANCE

**SANDWICH** est un fauteuil graphique et compact composé de deux volumes de mousse emboîtés, l'un formant un dossier ou un accoudoir, l'autre l'assise. **SANDWICH** est généreux dans ses dimensions, sa forme est un hybride entre un fauteuil et un ottoman. **SANDWICH** peut être multiplié et devenir une méridienne, un sofa, et également un îlot d'assises, proposant ainsi de nouvelles ergonomies et usages. **SANDWICH** est fabriqué en France et est décliné dans des finitions tissus adaptées au contract, à l'hôtellerie et à l'habitat, ainsi que dans des collections en éco-textile.

Design : Marine Peyre

**SANDWICH** is a graphic, compact and modular seat, composed of two interlocking blocks, one forming the backrest and armrest, the other forming the seat. **SANDWICH** has generous dimensions, creating a hybrid seat between an ottoman and an armchair. **SANDWICH** can be multiplied to become a meridian, a sofa, and can also create island seating configurations. **SANDWICH** is made in France and available in fabric for contract, hotel and home use, as well as in eco-textile collections.

Design : Marine Peyre



# SANDWICH



INVENTIF  
INVENTIVE

# SANDWICH

CREATIF  
CREATIVE



# SANDWICH

AUDACIEUX  
AUDACIOUS



# SANDWICH

MODULABLE  
MODULAR



# SANDWICH

MINIMAL  
MINIMAL



# SANDWICH

LUDIQUÉ  
PLAYFUL





SANDWICH



RESPONSABLE  
RESPONSIBLE

# SANDWICH

marinepeyre  
éditions

## ELEGANT ELEGANT

Une sélection de gamme de couleurs à combiner en elles, en monochrome, bicolore ou mix&match de textures.

A selection of color ranges to combine with each other, in monochrome, two-tone or mix&match.

Tissus éco conçus Tempt Gabriel®  
Eco textil Tempt Gabriel®

100 % laine Nobel Gabriel®  
100% wool Nobel Gabriel®

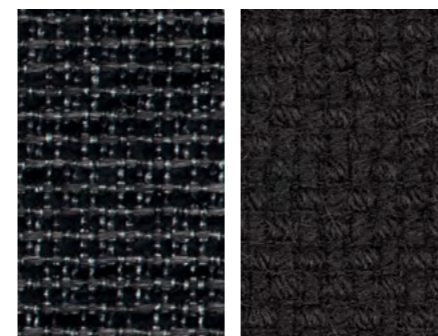
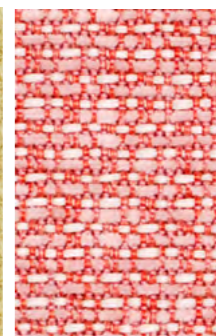
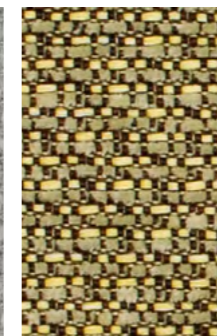
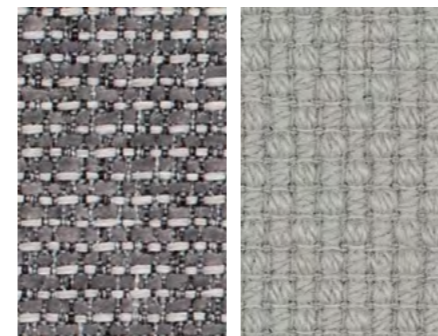
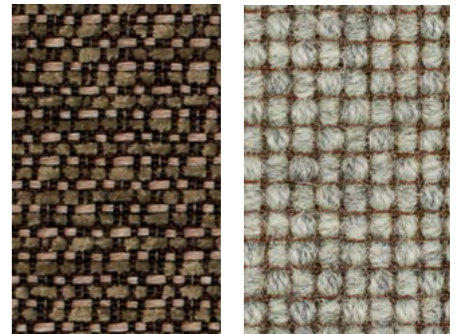

Tempt

Nobel

Autres finitions tissus disponible sur tarif,  
Tissus client sur demande.

Others fabrics available on price list,  
Custom fabrics on demand.

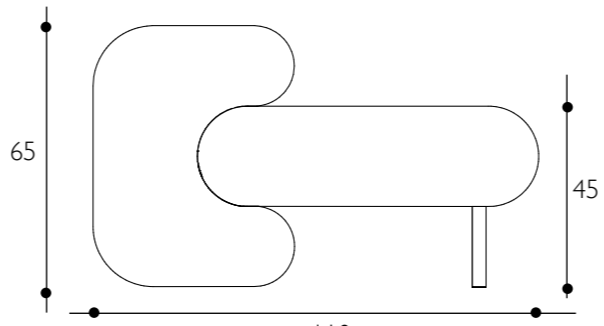
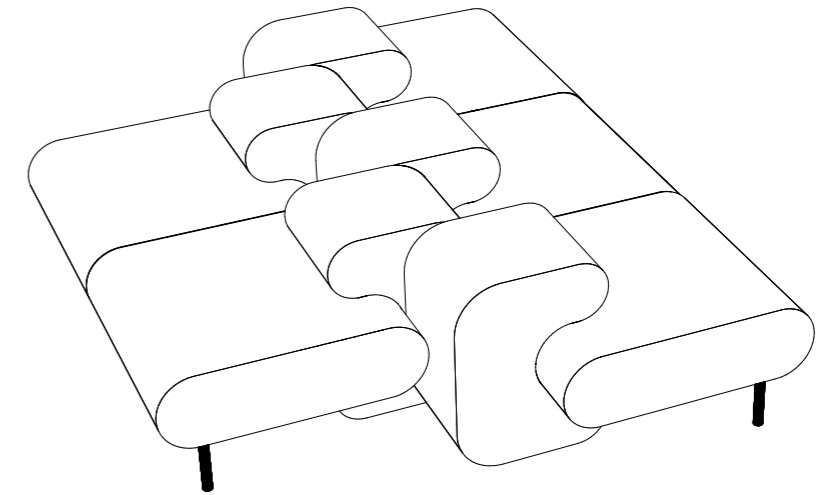
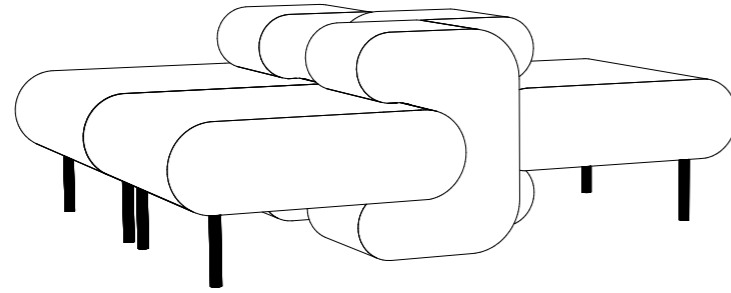
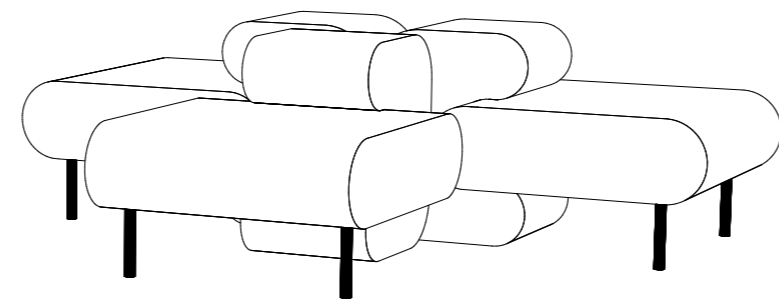
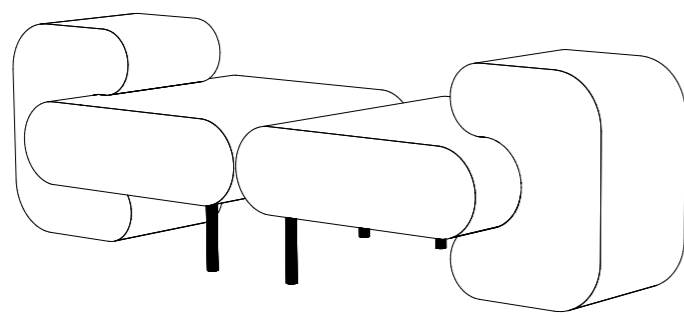
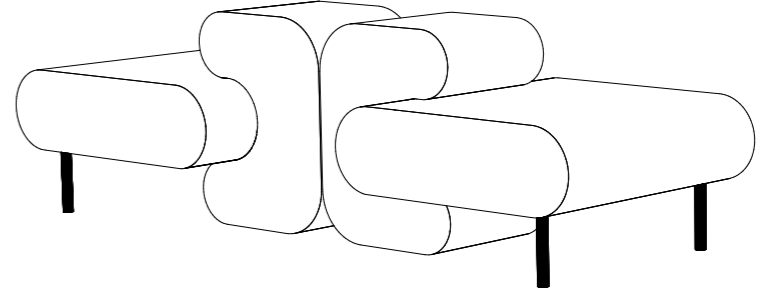
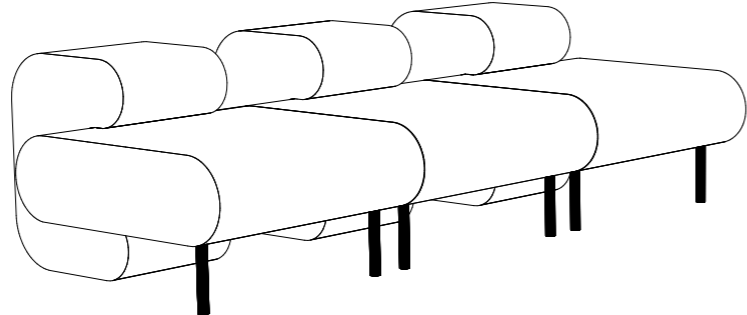
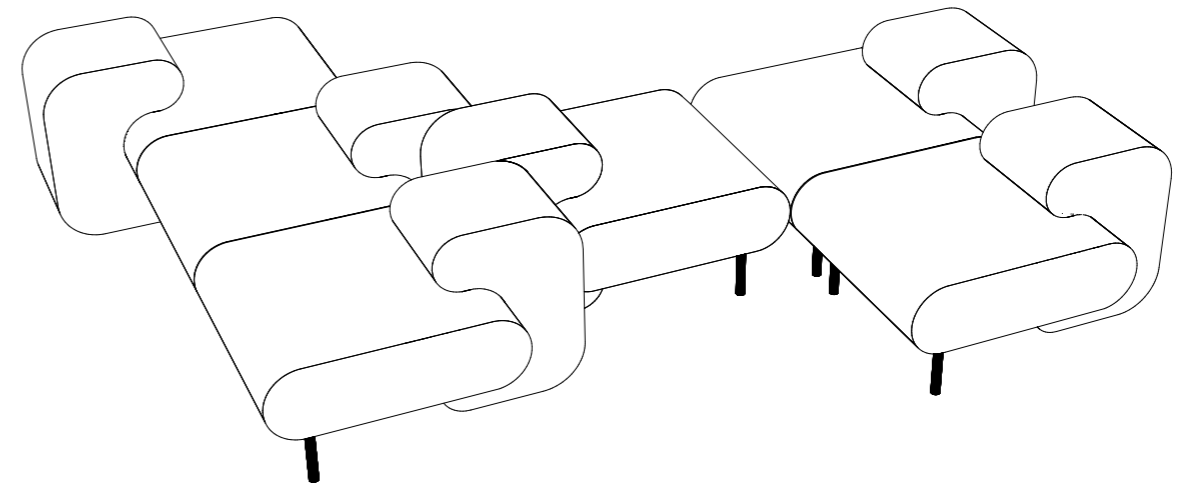
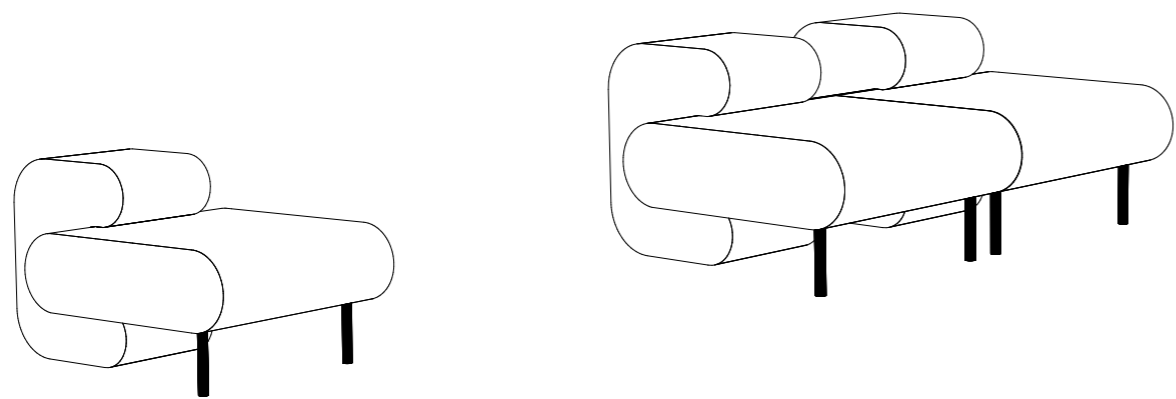

largeur / width : 80





# SANDWICH

# TARIFS ET FINITIONS

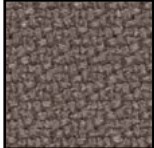

## PRICE LIST AND FABRICS

### ESPACE COLLABORATIFS / COLLABORATIVE SPACES

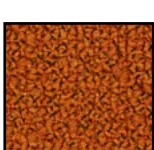
### PRIX PUBLIC HT PUBLIC PRICES EXCLUDING VAT

	<b>STEP GABRIEL®</b> 100 % Trevira cs martindale 100 000 OEKO-TEX® STANDARD 100 EU Ecolabel	1683 €
	<b>STEP MÉLANGE GABRIEL®</b> 100 % Trevira cs martindale 100 000 OEKO-TEX® STANDARD 100 EU Ecolabel	1767 €
	<b>CHILI GABRIEL®</b> 100% Post-consumer Recycled Polyester fr martindale 60 000 OEKO-TEX® STANDARD 100 EU Ecolabel	1755 €
	<b>BLEND GABRIEL®</b> 100% Post-consumer Recycled Polyester fr martindale 100 000 OEKO-TEX® STANDARD 100 EU Ecolabel	1743 €
	<b>GRAIN GABRIEL®</b> 92% Post-consumer Recycled Polyester / 8% Polyester martindale 100 000 OEKO-TEX® STANDARD 100 EU Ecolabel	1826 €





### TOILE ENDUITES/ PU

	<b>STAMSKIN ZEN STAMSKIN TOP SERGE FERRARI®</b> Composite multilayer martindale 120 000 Recyclable	1743 €
	<b>ZEST PANAZ®</b> PVC martindale 200 000	1612 €
	<b>TWEEDY VYNIL PANAZ®</b> PVC martindale 100 000 Latex free, phtalate free	1612 €



couleurs au choix selon nuancier / colors according to range

### HÔTELS / HOSPITALITY

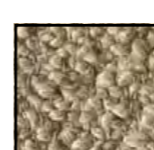
### PRIX PUBLIC HT PUBLIC PRICES EXCLUDING VAT

	<b>LUXE PERFORMANCE VELVET PANAZ®</b> 100 % Polyester martindale 70 000 waterproof	1683 €
	<b>ASCOT ELASTRON®</b> 100 % Polyester martindale 80 000 OEKO-TEX® STANDARD 100 REACH COMPLIANT	1635 €
	<b>TEMPT GABRIEL®</b> 100 % Recyclable Polyester martindale 90 000 OEKO-TEX® STANDARD 100	1790 €
	<b>NOBEL GABRIEL®</b> 100 % New Zealand Wool martindale 90 000 OEKO-TEX® STANDARD 100 EU Ecolabel	2218 €
	<b>ORSETTO ONE MARIO SIRTORI®</b> 34% Viscose/ 33% Acrylic 17% Wool/ 8% Polyester/ 4% Flax 4% Cotton martindale 80 000	2218 €

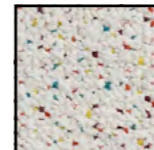
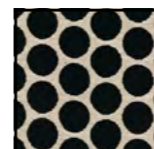
### COLLECTIONS SPÉCIALES/ SPECIAL EDITION

	<b>CARNIVAL ONE MARIO SIRTORI®</b> 40% Cotton/22% Acrylic 16% Viscose/11% Wool 11% Polyester martindale 100 000	1838 €
	<b>FIFTIES CASAMANCE®</b> 76 % Viscose /13 % pes /8 % Cotton /3 % lin martindale 45 000	2124 €
	<b>SLALOM CASAMANCE®</b> 69 %PC ; 20 % Pes ; 11 % Cotton martindale 30 000	2218 €

couleurs au choix selon nuancier / colors according to range

**suivez nous**

follow us

**[www.marinepeyre.com](http://www.marinepeyre.com)**

[mp@marinepeyre.com](mailto:mp@marinepeyre.com)

[@marinepeyreeditons](https://www.instagram.com/marinepeyreeditons)

©photographies  
Grégoire Borach

